

GVM

GVM-SD500B-ARO

CONTENTS

Important Safety Instructions	Page 1~2
Warning	Page 2
Product Introduction	Page 3
Disclaimers	Page 3
Product Parameter	Page 4
Precautions	Page 4
Product Structure Diagram	Page 5
Installation Method	Page 6~7
Description Of Product Control Keys	Page 8
Function Introduction & Instructions For Use	Page 9
APP Control	Page 10~12
Use And Preservation	Page 12
Quick Troubleshooting	Page 13
Packing List	Page 13
Product Warranty	Page 14~15

IMPORTANT SAFETY INSTRUCTIONS

First and foremost: this product is professional lighting and staging equipment and should be used by a professional lighting technician or under the guidance of a professional. When using this product, you must always follow the cautions below:





1. Read the product manual carefully before use.
2. This product is only suitable to use in a temperature range of -20°C to 45°C.
3. Do not place the equipment near flammable and volatile solvents such as alcohol and gasoline.
4. Before storing the device, make sure it has cooled down completely. When being stored, unplug the power cord from the device. The equipment should be stored in its carrying case or a well-ventilated and dry place.
5. This lighting fixture is not for general illumination and should not be used as such. Individuals with eye injuries or sensitivity should avoid using this lighting fixture.
6. This is a professional light and children are prohibited from using it. Parents or guardians must closely supervise children when they are near the equipment to prevent personal injury caused by colliding with or misusing the equipment.
7. Before using the equipment, please remove the protective cover.
8. When the lighting fixture is on, it is forbidden to stare directly at the light source under any circumstances. High-intensity lighting should only be used under the guidance of a professional lighting technician. Avoid staying in a high-intensity light environment for a long time. If feeling any discomfort, please immediately turn off the lighting fixture, and seek medical attention.
9. When the lighting fixture is on, use it carefully and avoid contacting high-temperature components such as LED light sources to prevent being burnt.
10. Do not use damaged equipment or accessories. Wait for a professional repairman to inspect and repair it before it is confirmed that the equipment can function normally.
11. If the light source is damaged or deformed due to heat, please stop using it and contact the manufacturer, service agents, or qualified repairman promptly to replace the light source to avoid accidents.
12. If the product is cracked due to falling, squeezing, or strong impact during use, please stop use it to avoid being electrically shocked by touching internal electronic components.
13. Do not disassemble the product by yourself. If the product malfunctions, it must be checked and repaired by the manufacturer or authorized repair personnel.
14. Before cleaning and maintenance, be sure to unplug the power supply. To unplug never pull on the cable but always pull the plug itself. This device shall only operate with earthed power outlets or emergency power generators.
15. When cleaning the device, do not wipe it with a wet cloth. Use a dry and soft cloth to wipe off the dirt.
16. If an extension cord is required, it needs to have the necessary capacity to power the respective unit. Using an extension cord with a lower current capacity than the devices need may cause overheating.

17. For some products with long power cords, please place the power cords properly and avoid contact with overheated surfaces that may damage or trip personnel. Please use the original power cords of our manufactory. The damage caused by using non-original power cords is not covered by our repair service.
18. Do not use product accessories that are not recommended by our brand to avoid fire, electric shock, or personal injury.
19. Some products use batteries for power supply. Do not use any batteries, power sources, or accessories that are not specified in the user manual. Please keep batteries and other accessories out of reach of children and infants. If a child or infant swallows a battery or accessory, seek medical attention immediately. If the battery leaks, changes color, deforms, smokes, or emits an odor, remove it immediately. Be careful not to get burned during the removal. Continued use of such batteries may cause a fire, electric shock, or skin burns. Do not use any deformed or modified batteries. Do not disassemble or modify this product or the battery. Do not heat the battery or solder it. Do not let the battery come into contact with fire or water, or subject it to strong external force. Do not insert the battery's positive and negative ends incorrectly, or mix and use old and new batteries or different types of batteries.
20. For some products with built-in lithium batteries, please use a dedicated charger for charging, and following the correct operating instructions within the prescribed voltage and temperature range.
21. The warranty last for one year. Consumables like batteries, adapters, power cords, and other accessories are not covered by the warranty.
22. The one-year warranty will be invalidated if the equipment is found to have been repaired privately. The related repair costs will be charged.
23. Equipment malfunctions caused by non-standard operations are not covered by the warranty.
24. The safety instructions are based on our factory's strict testing. If there are any changes in the equipment's design and specifications, we reserve the right not to notify you. Customers can visit our official website to check the latest digital version of the instructions and learn about the newest product information.

Keep these instructions!



WARNING:

-  High-power LED lights are strictly prohibited from being directly viewed or shining into other people's eyes.
-  Do not unplug the power cord or connecting wires while the light is on to avoid personal injury.
-  Do not cover the heat dissipation port when the lamp is in operation.
-  Keep children away from touching or using this light.
-  As professional lighting equipment, please make sure to operate it correctly according to the user manual.

PRODUCT INTRODUCTION

Thank you for choosing the GVM-SD500B-ARO. This high-performance COB LED light is designed with the needs of professional photographers and videographers in mind. It is perfect for a wide range of creative scenarios, including live broadcasting, outdoor and studio photography, as well as YouTube video production. Whether you're working in film, television, or digital media, this versatile lighting solution delivers consistent, high-quality illumination for every shot.

The main features of the product are:

1. Equipped with high-definition COB LED beads, this light enhances color accuracy and richness, delivering natural and high-quality illumination that brings out the true colors of your subjects.
2. APP control, Enhance your lighting experience with the [GVM Link] APP, available for both iOS and Android devices. Utilizing the innovative GVM Mesh Bluetooth networking system, this app allows for seamless connectivity and effortless control. With its intuitive interface, you can enjoy faster response times and more efficient control over your lighting setup, providing greater convenience and precision in managing your shoots.
3. With standard DMX input, a low precision 8bit and a high precision 16bit DMX control can be achieved.
4. 2 lighting modes, CCT mode, FX Mode.
CCT Mode: Offers a white light mode with adjustable light intensity and color temperature for precise control.
FX Mode: Features 12 dynamic lighting effects, including Intensity Loop, Lightning, Bad Bulb, Paparazzi, Explosion, Pulsing, Strobe, Welding, SOS, CCT Loop, TV, and Candle, allowing for creative and cinematic lighting in various scenarios.

We firmly believe that the correct use of this product will be of great help to your shooting workflow. It is strongly recommended that you read the following user guide carefully before using the product.

DISCLAIMERS

1. Before using this product, please read the text carefully to ensure that the correct operation of the product is carried out. Failure to follow and not following the instructions and warnings in this document may cause damage to the product or other surrounding items, or even harm you and others around you.
2. By using this product, you are deemed to have carefully read the disclaimer and warning, understand and agree all the terms and contents of this statement, and promise to take full responsibility for the use of this product and the possible consequences.
3. Design and specifications are subject to change without notice.

PRODUCT PARAMETER

- ◆ Brand : GVM
- ◆ Product Model : GVM-SD500B-ARO
- ◆ Product Name : LED Video Light
- ◆ Product Type : LED COB Light
- ◆ Features : CCT/FX Modes, New LCD Display, High Definition COB LED Beads
- ◆ Control Methods : GVM Mesh Bluetooth APP Control, On Board Control
- ◆ Bluetooth Controllable Distance : ≤50M
- ◆ Light Adjustment Method : Step-less Adjustment
- ◆ Color Rendering Index : ≥97
- ◆ Color Temperature : 2700K~6800K
- ◆ Illumination : Bare bulb 23800 lux@1m, 2680 lux@3m;
Standard reflector 556400 lux@1m, 20900 lux@3m
- ◆ Power : 500W
- ◆ Product Net Weight : 6.65KG
- ◆ Product Size (mm) : 324×178×165
- ◆ LED Beads Quantity : 1 (COB lamp beads)
- ◆ Power Supply Method : AC
- ◆ Voltage : AC:100V~240V
- ◆ Cooling : Internal Active Cooling Fan
- ◆ Product Material : Aluminum Alloy + Plastic
- ◆ Commodity Origin : Huizhou. China

PRECAUTIONS

1. The product is not waterproof, please use it in a rainproof environment.
2. The product is not anti-corrosion, therefore do not let the product touch any corrosive liquid.
3. When using the product, make sure the product is put firmly and prevents falling and damage.
4. If the product will not be used for a long time, please switch off the power to reduce energy loss.

PRODUCT STRUCTURE DIAGRAM

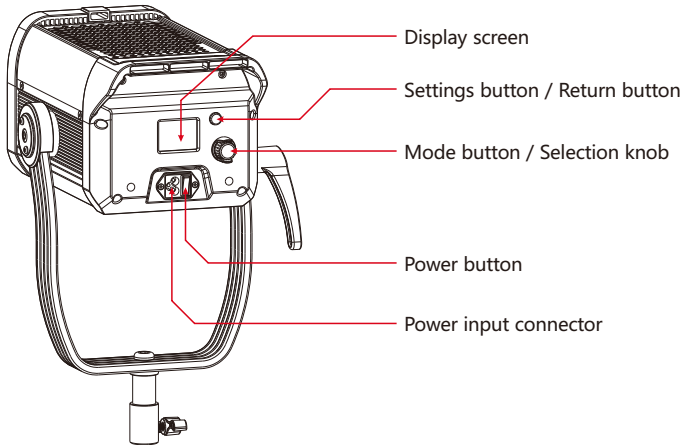
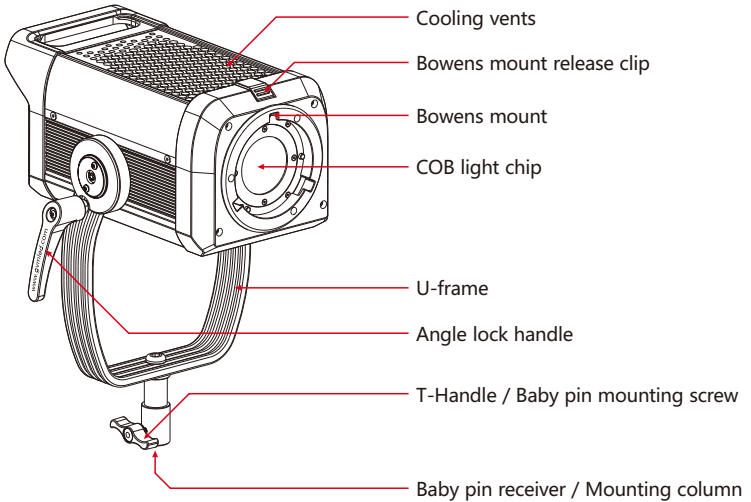

INSTALLATION METHOD

- 1 Loosen the light stand fixing knob, then mount the light onto the light stand as shown below, then tighten the light stand fixing knob to fix the light in place.

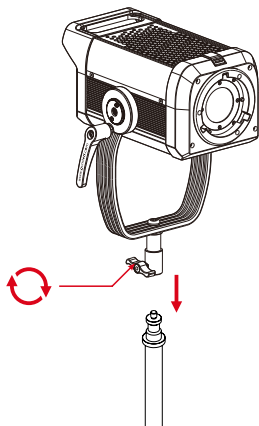

- 2 Loosen the angle locking handle, adjust the angle of the spotlight, then tighten the angle locking handle to fix the light in desired position.

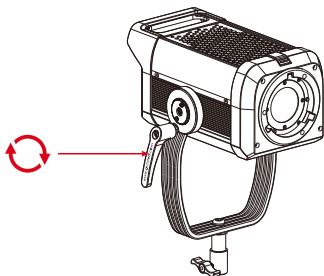

- 3** Insert the standard Bowens Reflector into the corresponding Bowens mount socket of the light, then turn it clockwise gently. To remove the reflector from the light, pull back the Bowens mount release clip and rotate the reflector counterclockwise.

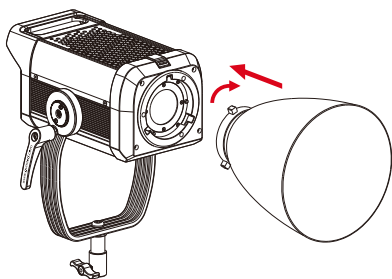

Attach

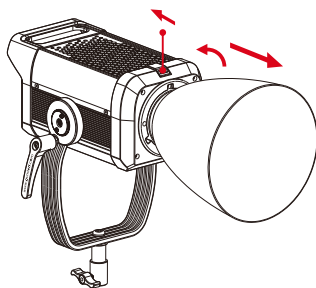

Detach

- 4** Connect the power cord to the power supply.

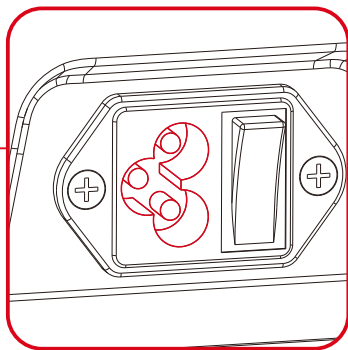
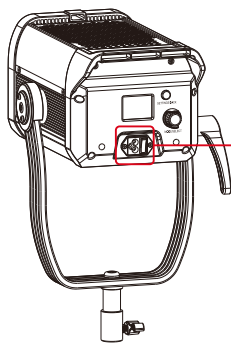

Power input connector

DESCRIPTION OF PRODUCT CONTROL KEYS

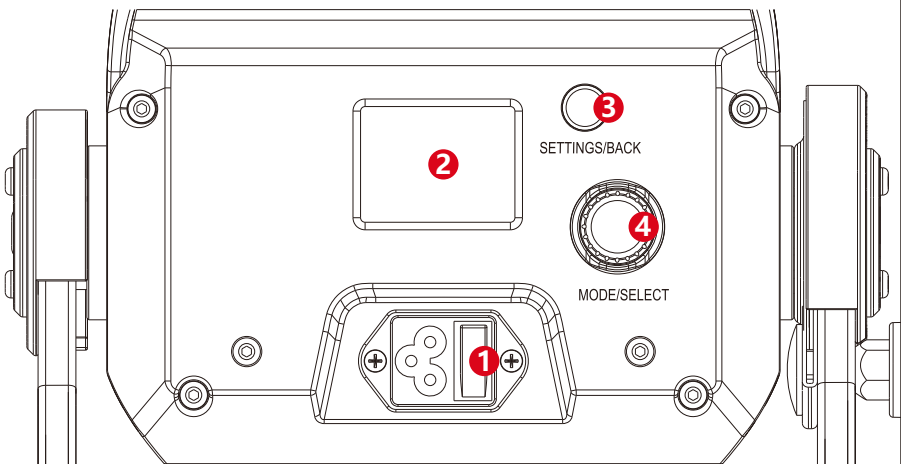

- 1** Power ON/OFF button:
Power status of the connected/disconnected light.
- 2** Display screen:
Display current settings, modes and parameters.
- 3** Settings button / Return button:
 - 1. Press and hold to enter [System Settings].
 - 2. Click to return to the previous menu.
- 4** Mode button / Select knob:
 - 1. Rotate the knob to adjust the parameters and selection.
 - 2. Click the knob to enter the menu of the current selection and confirm the selection.
 - 3. Press and hold to switch between [CCT] mode and [FX] mode.

FUNCTION INTRODUCTION & INSTRUCTIONS FOR USE

① CCT Mode:

Light intensity and color temperature can be adjusted in this mode.

Turn the knob to select the parameters you want to adjust → Click the knob to enter the parameter settings → for selected items → Turn the knob to adjust parameter values → Click in the knob to confirm the selection.

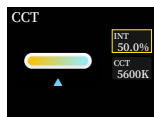

② FX Mode:

This mode provides 12 light effects: Intensity Loop, Lightning, Bad Bulb, Paparazzi, Explosion, Pulsing, Strobe, Welding, SOS, CCT Loop, TV, Candle.

Turn the knob to select the parameters you want to adjust → Click the knob to enter the parameter settings → for selected items → Turn the knob to adjust parameter values → Click in the knob to confirm the selection.

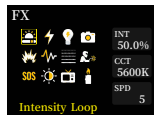

③ SETTINGS:

Press and hold the [SETTINGS] button to enter [SETTINGS] → Rotate knob to select menu → Click knob to enter menu → Rotate knob to select item → Click knob to confirm the current selection; Click the [BACK] button to return to the previous menu page.

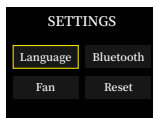

Language: Set the system language.

Bluetooth: Bluetooth switch, Bluetooth reset.

Fan: Set the heat dissipation fan mode.

Reset: View system information and restore factory Settings.

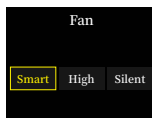
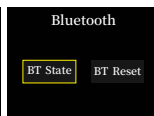

APP CONNECT

[GVM Link] APP installation method:

Android: Download from the GVM official website, or scan the QR code to download.

iOS: Download from the App Store.



Preparation for connection:

1. Start the device → E150 Bluetooth Settings → Bluetooth on → Bluetooth reset.
2. Keep the device within the connection range.
3. Turn on the Bluetooth function on your smart devices. (Android phones need to turn on location service)
4. APP permissions: Enable Bluetooth permissions. (Android phones need to enable positioning permissions to find nearby devices)

* The Android system needs to enable location permissions to connect devices using Mesh technology, and we do not collect any location information from you during this process.

Connection steps:

1. Create a new project → Tap to enter the project.

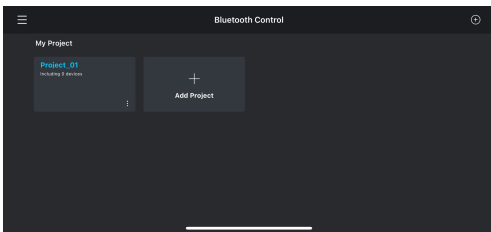

2. Tap the Add Device button.

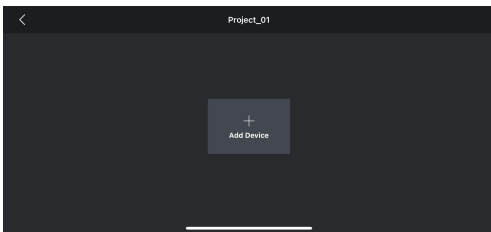

3. Select the device in the search list → Start connecting.

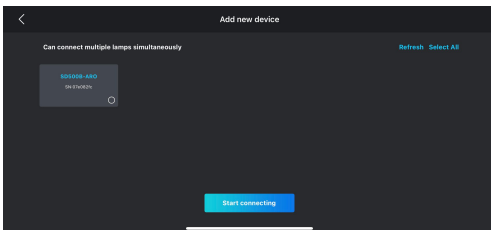

Lighting control:

Select the connected lighting device → Select Control Mode → Adjust lighting parameters.

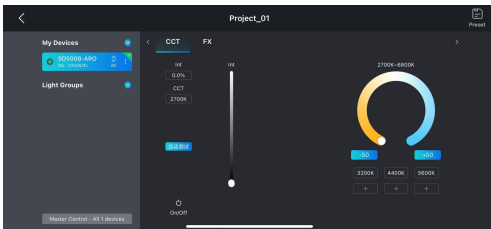

OTA Firmware upgrade:

1. Click the menu button on the right of the lighting device → Select Firmware update from the menu → View available firmware.

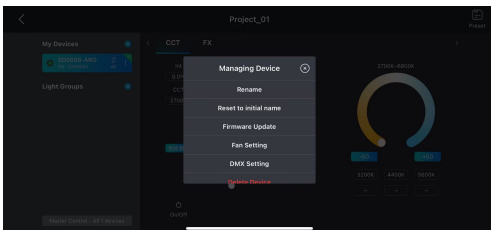

2. Select new available firmware → Click Update.

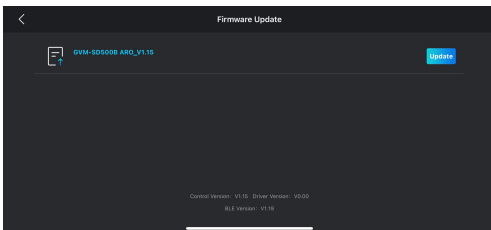

3. The firmware upgrade usually takes 5-10 minutes. During the upgrade, do not leave the current page and keep the device connected.

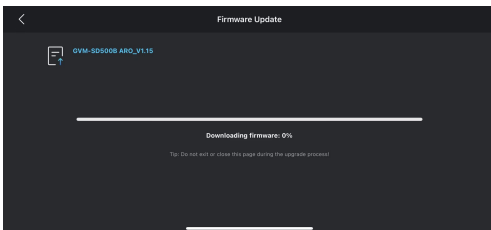

USE AND PRESERVATION

Do not place the product in a high humidity, strong electromagnetic field, direct sunlight, or high-temperature environment. If the product will not be used for a long time, please disconnect its power.

Clean: Before cleaning, disconnect the power plug. And use a damp cloth instead of any detergent or soluble liquids to avoid damaging the surface layer.

Power: Make sure the power is within the demanded range, not too high or too low.

Repairing: If there is a fault or performance degradation, do not unpack the shell by yourself, avoiding damage to the machine and losing the right of maintenance. When there is a fault, do not hesitate to contact us, and we will do our best to deal with the problem.

Accessories: Please use the accessories provided by the manufacturer and approved ones, to maximize the performance.

Warranty: Do not modify the product, or you will lose the right to maintenance.

QUICK TROUBLESHOOTING

Issue	Check the product	Troubleshooting
The indicator does not light up.	Whether the connection between the light and the power supply is normal.	Make sure the adapter is well connected with the power plug.
In the App, the blue tooth device can not be found.	Check the Bluetooth status of the phone and device to ensure that the device distance is within the connection range.	Check the cause according to the APP [Connection Preparation] step and keep the device within the connection range.
The APP failed to connect to the device.	Check the Bluetooth status of the phone and device to ensure that the device distance is within the connection range.	Restart the APP and the device, reset the Bluetooth of the device, and keep the device within the connection range.
The device is displayed offline.	Check the Bluetooth status of the phone and device to ensure that the device distance is within the connection range.	<ol style="list-style-type: none">1. Keep the device in the connection range, restart the device, and check whether the APP connection is restored.2. Refer to the APP [Connection Steps], reset the Bluetooth of the device to reconnect.

PACKING LIST

Name	Quantity	Notes
GVM COB Spotlight	1	
Standard Reflector	1	
Spotlight Protective Cover	1	
AC Power Cable	1	
Magic Cable Tie	2	
Instructions	1	

PRODUCT WARRANTY

Dear user, this warranty card is important proof for applying for warranty service. Please cooperate with the salesperson to fill it out and keep it properly. Thank you!

Product Information	Model Number	Product Barcode
User Information	Name	Contact Number
	Mailing Address	
Seller Information	Name	
	Contact Number	
	Mailing Address	
	Sales Date	
Remarks		

Note: this form should be confirmed by the salesperson's stamp.

Applicable Products

This document applies to the products listed in the relevant "Product Warranty Information" (see instructions below). Other products or components that do not fall within this scope (such as promotional products, gift items, and other components added after the factory) are not covered by this warranty promise.

Warranty Period

The corresponding warranty period for products and components shall be executed according to the relevant "Product Warranty Information". The warranty period starts from the first day of purchase of the product, and the date of registration on the warranty card at the time of purchase shall prevail.

How to Obtain Warranty Service

You can directly contact the product salesperson or authorized service agency, or call GVM's after-sales service hotline to contact us and have our service personnel arrange service for you. When applying for warranty service, you should provide a valid warranty card as a warranty certificate to be eligible for warranty service. If you cannot provide a valid warranty card, we may also provide you with warranty service under the circumstance that our products or components are confirmed to be within the warranty scope, but this is not our obligation.

Cases where warranty does not apply:

If the product meets the following conditions, the warranty and service under this document will not apply:

1. The product or parts have exceeded the corresponding warranty period.
2. Malfunctions or damages caused by incorrect or improper use, maintenance, or storage, such as improper handling, use for purposes other than the reasonable expectations of the product, incorrect insertion or removal of external devices, falling or crushing due to external force, or exposure to inappropriate temperature, solvents, acids, alkalis, water immersion, or damp environments.
3. Malfunctions or damages caused by unauthorized installation, repair, modification, addition, or disassembly by institutions or personnel not authorized by GVM.
4. Modifications, changes, or removals of the original identification information of the product or its parts.
5. Lack of valid warranty card.
6. Malfunctions or damages caused by the use of unauthorized, non-standard or non-publicly released software.
7. Malfunctions or damages caused by force majeure or accidents.
8. Other malfunctions or damages not caused by quality issues of the product itself. In such cases, you should seek solutions from the relevant responsible parties, and GVM will not be held liable. Malfunctions or damages caused by components, accessories, or software not covered by the warranty or beyond the warranty scope that renders the product unable to function properly are not covered by the warranty. Fading, wear, and consumption that is normal during the product usage process are not covered by the warranty.

Product Warranty and Service Support Information

The product warranty period and service types are implemented according to the following "Product Warranty Information" for each product category, component, and optional equipment:

Product Category	Accessories Name	Warranty Period(Month)	Warranty Service Type
Component	Circuit Board.	12 Month	Customer service repair
Other	Spotlight mount, softbox, adapter, Standard reflector, power cord, battery Handle, light stand, TYPE-C cable, battery slot, battery, Fresnel lens, grid, carrying bag and all other accessories, etc. Consumable or electrically sensitive parts are not covered by the warranty.	None	No Warranty

**QC
PASS**



GVM Official Website



Facebook

Huizhou Latu Film Equipment Co., Ltd.

Web: www.gvmled.com

B&H Email: bh@gvmled.com

GVM Email: support@gvmled.com

Amazon Email: amazonsupport@gvmled.com

Warehouse Address: 12285 MCNULTY RD, STE 105 PHILADELPHIA, Pennsylvania 19154, USA