

GVM

GVM SD300C AIO

CONTENTS

Important Safety Instructions	Page 1~2
Warning	Page 2
Product Introduction	Page 3
Disclaimers	Page 3
Product Parameter	Page 4
Precautions	Page 4
Product Structure Diagram	Page 5
Installation Method	Page 6~8
Description Of Product Control Keys	Page 9
Function Introduction & Instructions For Use	Page 10~13
APP Control	Page 14~15
Quick Troubleshooting	Page 16
Use And Preservation	Page 17
Packing List	Page 17
Product Warranty	Page 18~19

IMPORTANT SAFETY INSTRUCTIONS





This product is professional lighting and staging equipment and should only be operated by a qualified lighting technician or used under the supervision of a professional. Always follow the precautions below to ensure safe and proper usage.

1. Read the product manual carefully before use.
2. This product is only suitable to use in a temperature range of -20°C to 45°C.
3. Do not place the equipment near flammable and volatile solvents such as alcohol and gasoline.
4. Before storing the device, make sure it has cooled down completely. When being stored, unplug the power cord from the device. The equipment should be stored in its carrying case or a well-ventilated and dry place.
5. This lighting fixture is not for general illumination and should not be used as such. Individuals with eye injuries or sensitivity should avoid using this lighting fixture.
6. This is a professional light and children are prohibited from using it. Parents or guardians must closely supervise children when they are near the equipment to prevent personal injury caused by colliding with or misusing the equipment.
7. Before using the equipment, please remove the protective cover.
8. When the lighting fixture is on, it is forbidden to stare directly at the light source under any circumstances. High-intensity lighting should only be used under the guidance of a professional lighting technician. Avoid staying in a high-intensity light environment for a long time. If feeling any discomfort, please immediately turn off the lighting fixture, and seek medical attention.
9. When the lighting fixture is on, use it carefully and avoid contacting high-temperature components such as LED light sources to prevent being burnt.
10. Do not use damaged equipment or accessories. Wait for a professional repairman to inspect and repair it before it is confirmed that the equipment can function normally.
11. If the light source is damaged or deformed due to heat, please stop using it and contact the manufacturer, service agents, or qualified repairman promptly to replace the light source to avoid accidents.
12. If the product is cracked due to falling, squeezing, or strong impact during use, please stop use it to avoid being electrically shocked by touching internal electronic components.
13. Do not disassemble the product by yourself. If the product malfunctions, it must be checked and repaired by the manufacturer or authorized repair personnel.
14. Before cleaning and maintenance, be sure to unplug the power supply. To unplug never pull on the cable but always pull the plug itself. This device shall only operate with earthed power outlets or emergency power generators.
15. When cleaning the device, do not wipe it with a wet cloth. Use a dry and soft cloth to wipe off the dirt.
16. If an extension cord is required, it needs to have the necessary capacity to power the respective unit. Using an extension cord with a lower current capacity than the devices need may cause overheating.

17. For some products with long power cords, please place the power cords properly and avoid contact with overheated surfaces that may damage or trip personnel. Please use the original power cords of our manufactory. The damage caused by using non-original power cords is not covered by our repair service.
18. Do not use product accessories that are not recommended by our brand to avoid fire, electric shock, or personal injury.
19. Some products use batteries for power supply. Do not use any batteries, power sources, or accessories that are not specified in the user manual. Please keep batteries and other accessories out of reach of children and infants. If a child or infant swallows a battery or accessory, seek medical attention immediately. If the battery leaks, changes color, deforms, smokes, or emits an odor, remove it immediately. Be careful not to get burned during the removal. Continued use of such batteries may cause a fire, electric shock, or skin burns. Do not use any deformed or modified batteries. Do not disassemble or modify this product or the battery. Do not heat the battery or solder it. Do not let the battery come into contact with fire or water, or subject it to strong external force. Do not insert the battery's positive and negative ends incorrectly, or mix and use old and new batteries or different types of batteries.
20. For some products with built-in lithium batteries, please use a dedicated charger for charging, and following the correct operating instructions within the prescribed voltage and temperature range.
21. The warranty last for one year. Consumables like batteries, adapters, power cords, and other accessories are not covered by the warranty.
22. The one-year warranty will be invalidated if the equipment is found to have been repaired privately. The related repair costs will be charged.
23. Equipment malfunctions caused by non-standard operations are not covered by the warranty.
24. The safety instructions are based on our factory's strict testing. If there are any changes in the equipment's design and specifications, we reserve the right not to notify you. Customers can visit our official website to check the latest digital version of the instructions and learn about the newest product information.

Keep these instructions!

WARNING:

-  High-power LED lights are strictly prohibited from being directly viewed or shining into other people's eyes.
-  Do not unplug the power cord or connecting wires while the light is on to avoid personal injury.
-  Do not cover the heat dissipation port when the lamp is in operation.
-  Keep children away from touching or using this light.
-  As professional lighting equipment, please make sure to operate it correctly according to the user manual.

PRODUCT INTRODUCTION

Thank you for purchasing the "GVM SD300C AIO". This product is designed for photographers, videographers, and other professional users. This product is applicable to use in live streaming, in door/ outdoor film and television productions, photography sessions, etc.

The key features of the product are:

1. The LEDs used in this product feature a high color rendering index (CRI>97), enabling precise reproduction of colors, textures, and skin tones. The result is a natural, high-fidelity illumination ideal for professional imaging.
2. This light features advanced Bluetooth Mesh networking, allowing it to communicate seamlessly with other GVM devices that support the same technology. Through the GVM App, you can achieve stable wireless performance and unified group control across multiple lights, ensuring a more efficient and coordinated lighting workflow.
3. **Optional Data Box Compatibility.**
This product is compatible with several optional GVM data boxes (sold separately), enabling expanded professional control capabilities. Supported models include:
 - DCB-XLR5 — 5 -Pin DMX wired control.
 - CCB-XLR5 — CRMX wireless DMX + Wired DMX control.
 - LCB-RJ45 — Art-Net and sACN control via Ethernet. By integrating these accessories, the light can access advanced industry-standard protocols such as wired DMX, LumenRadio wireless DMX, and Art-Net/sACN network control, providing a more robust and flexible lighting workflow.
4. **Six Lighting Modes for Creative Control.** This fixture offers six powerful lighting modes to support a wide range of creative and professional applications:
 - CCT Mode – Adjust color temperature and brightness from warm to cool white for natural lighting control.
 - HSI Mode – Set precise colors by adjusting hue, saturation, and intensity.
 - RGB Mode – Create custom colors by independently controlling red, green, and blue channels.
 - Color Gel Mode – Simulate industry-standard color gels for accurate scene matching.
 - Light Source Mode – Reproduce the characteristics of 12 common lighting sources.
 - Lighting Effects Mode – Access 16 cinematic lighting effects for dramatic or practical scene enhancement.

Note: Lighting Effects Mode is available only through the GVM App or via DMX, LumenRadio CRMX, or Art-Net when used with a compatible GVM data box.

We firmly believe that proper use of this product will greatly enhance your production workflow. We strongly recommend reading the following user guide carefully before using the product.

DISCLAIMERS

1. Before using this product, please read the text carefully to ensure that the correct operation of the product has been carried out. Failure to follow and not following the instructions and warnings in this document may cause harm to you and others around you, or even damage the product or other surrounding items.
2. By using this product, you are deemed to have carefully read the disclaimer and warning, understand and acknowledge all the terms and contents of this statement, and promise to take full responsibility for the use of this product and the possible consequences.
3. Design and specifications are subject to change without notice.

PRODUCT PARAMETER

- ◆ Brand: GVM
- ◆ Product Model: GVM SD300C AIO
- ◆ Product Name: All-in-one Video Light
- ◆ Product type: LED COB Light
- ◆ Features: CCT/HSI/RGB/ Color Gel/Light Sources/Lighting Effects, LCD screen, high color rendering index LED beads
- ◆ Control methods: On-board control, Control through three types of data box accessories, and Bluetooth APP control
- ◆ The data port can be used to connect with the following accessories:
DCB-XLR5(DMX/RDM)
CCB-XLR5(CRMX/RDM),
LCB-RJ45(Ethernet Art-Net/sACN))
**The accessories needs to be purchased separately*
- ◆ Bluetooth controllable distance: ≤ 50 meters
- ◆ Number of LED beads: 1 (COB)
- ◆ Light adjustment method: Stepless adjustment
- ◆ Color rendering index: $\geq 97+$
- ◆ Color temperature: 2000K to 10000K
- ◆ Illuminance: 13300 lux@1m; 1440 lux@3m
- ◆ Power: 300W
- ◆ Weight: 3.25KG
- ◆ Dimensions (mm) : 305×133×135
- ◆ Power supply mode: AC power supply
- ◆ Working voltage: AC 100V to 240V
- ◆ Heat dissipation: Radiator + fan
- ◆ Product material: Aluminum alloy + engineering plastic
- ◆ Product origin: China. Huizhou

PRODUCT STRUCTURE DIAGRAM

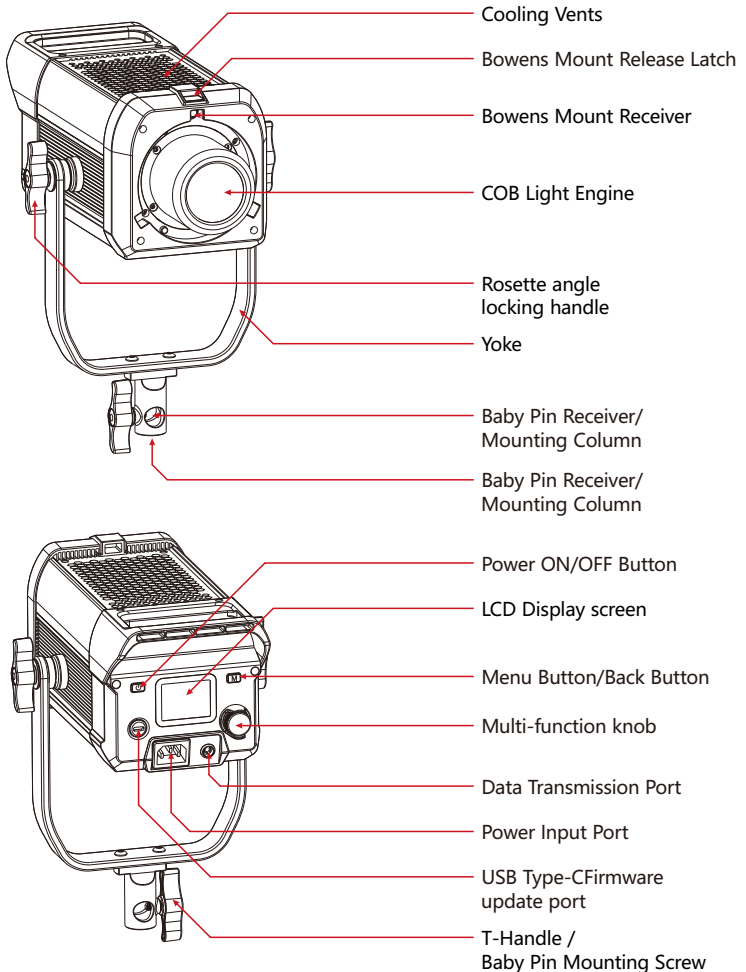

INSTALLATION METHOD

- 1 Slide the 5/8" receiver over the spigot/stud at the top of the light stand. Lower it fully down so the receiver fits snugly onto the stand. Tighten the securing knob on the yoke. Make sure the light does not wobble or spin.

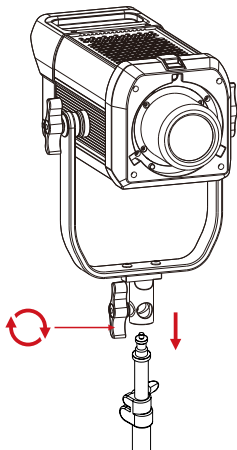

- 2 Loosen the angle locking handle on the side of the Yoke then adjust the tilt angle of the light to your needs, and then tighten the angle locking handle.

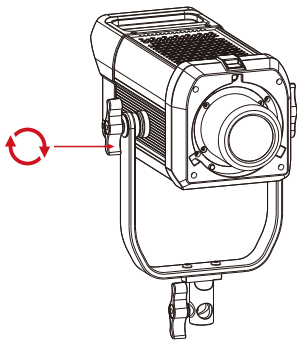

- 3** Installation and removal of the standard reflector.
(Standard reflector needs to be purchased separately.)

Installation:

Align and insert the three prongs of the reflector to the bowens mount receiver of the light. → gently rotate the reflector clockwise until you hear a click, indicating that it is securely locked into place.

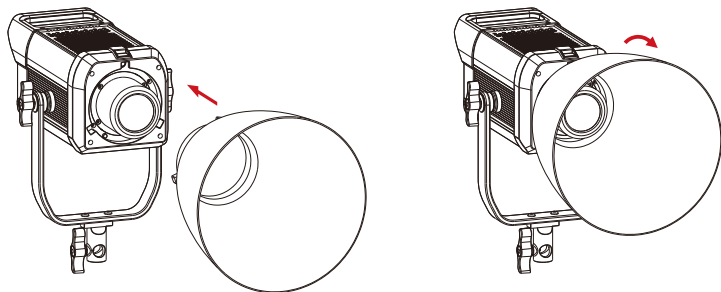

Detach:

Slide back and hold the Bowens mount release latch, then rotate the standard reflector counterclockwise until it loosens. Once unlocked, pull the reflector straight out to remove it.

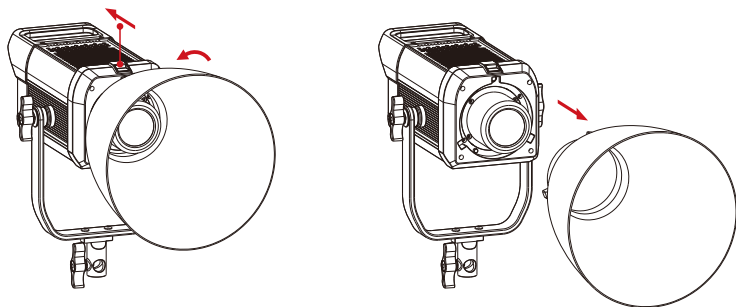

- 4** Connect the power cord to the power supply.

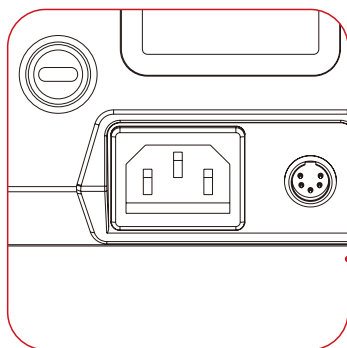

Powerinput port

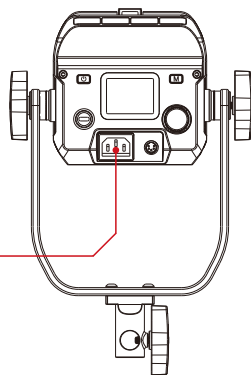

- 5** The data transmission port can be connected to the GVM Data Box accessories and corresponding control function can be carried out.

(The accessories need to be purchased separately. The supported accessories models includes: DCB-XLR5(DMX&RDM), CCB-XLR5(CRMX&DMX), LCBRJ45(Ethernet Art-Net/sACN).)

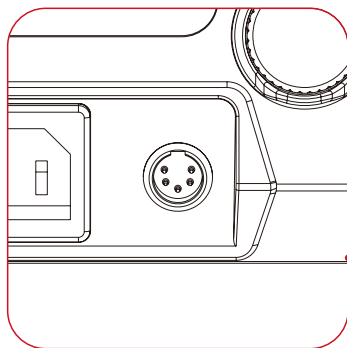

Data transmission port

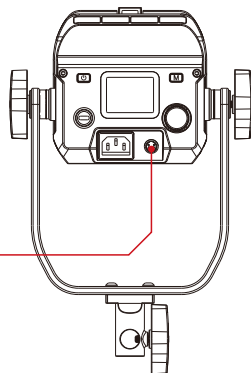

DESCRIPTION OF PRODUCT CONTROL KEYS

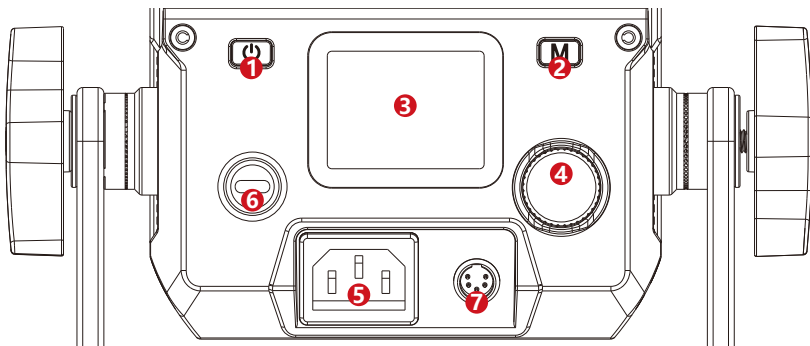

- 1** Power ON/OFF button: Press and hold this button to power on/off the fixture.
- 2** Menu key/Back key:
 - 【 Long press 】 Enter/exit the system menu interface;
 - 【 Short Press 】 Return to the previous level menu.
- 3** Display: Displays the current Settings, modes, and parameters.
- 4** Knob:
 - 【 Rotate the knob 】 Select Menu/Set Parameters;
 - 【 Press the knob briefly 】 Confirm the selection/enter the menu.
- 5** Power port: Connect to the power cable to supply power to the light.
- 6** USB TYPE-C port: Used for firmware update.
(Does not support power input for the fixture or charging of other digital devices such as mobile phones.)
- 7** Data transmission port: Connect the GVM BOX series accessories to achieve the corresponding control mode.
(The attachments need to be purchased separately. The supported attachment models are: DCB-XLR5(DMX&RDM), CCB-XLR5(CRMX&DMX), LCB-RJ45(Ethernet Art-Net/sACN).)

FUNCTION INTRODUCTION & INSTRUCTIONS FOR USE

MENU

Long press the [M] key to enter the system menu Settings → Rotate the [knob] to select the menu → Press the [knob] to enter the selected menu → Short press the [M] key to return to the previous level menu.

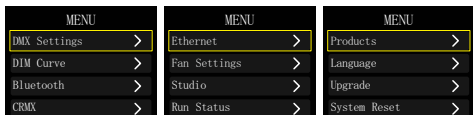

DMX Settings

This function can only be used after being connected to the GVM data box.

* The data box needs to be purchased separately. Supported data box models: DCB-XLR5, CCB-XLR5

Rotate the [knob] to select [DMX Address /DMX mode]→ Press the [knob] to confirm the selection.

DMX address: Rotate the [Knob] to set the DMX address number → Press the [knob] to confirm the setting.

DMX mode: Rotate the [knob] to select DMX mode → Press the [knob] to confirm the selection.



DIM Curve

Rotate the [knob] to select the type of dimming curve [linear/logarithmic/exponential/S-type]→ Press the [knob] to confirm the selection.

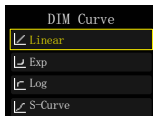

Bluetooth

Rotate the [knob] to select the type of dimming curve [BT State/BT Reset]→ Press the [knob] to confirm the selection.

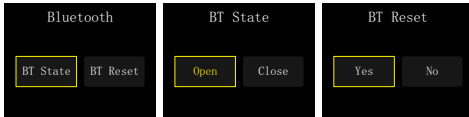

CRMX

This function can only be used after being connected to the GVM data box.

- The data box needs to be purchased separately. Supported data box model: CCB-XLR5

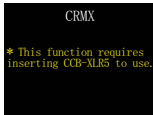

- After being connected to the CCB-XLR5 data box, it supports the DMX512 / RDM LumenRadio CRMX protocol.

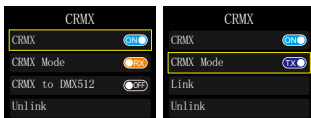

Ethernet

This function can only be used after being connected to the GVM data box.

* The data box needs to be purchased separately. Supported data box models: LCB-RJ45



- After being connected to the LCB-RJ45 data box, it supports the Art-Net protocol.

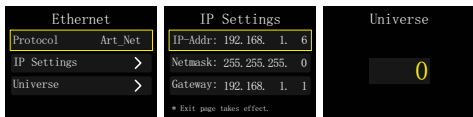

Fan Settings

Rotate the [knob] to select [Smart/High Speed/Silent] → Press the [knob] to confirm the selection.

Smart: Fan speed will be adjusted in response to the internal temperature changes.

High speed: The fan operates at its maximum speed.

Silent mode: The silent mode will shut off the fan from rotating and reduces the light's output power to 30W. This mode is not recommended for extended use.

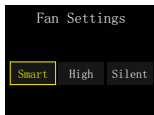

Studio

Rotate the [knob] to select [ON/OFF] → Press the [knob] to confirm the selection.

ON: Studio mode. In a power-off state, the equipment will automatically start up after being powered on.

OFF: Non-studio mode. In a power-off state, the equipment needs to be manually turned on after being powered on.

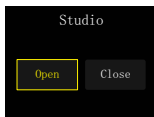

Fan Status

Check the current internal temperature and fan speed of this product.

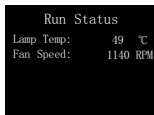

Products

View the system/ firmware information of this product.



Language

Rotate the [knob] to select the language type [English/ Chinese] → Press the [knob] to confirm the selection.



Upgrade

Download the firmware file from the official GVM website to the root directory of the USB drive → Connect the USB drive with the upgrade firmware to the fixture → Rotate the [knob] to select [Yes/No] upgrade → Press the [knob] to confirm the selection. Control modules' firmware can also be upgraded from this menu page.

Supported USB flash drive format: FAT32

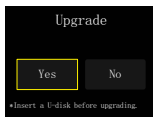





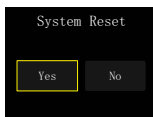





System Reset

Rotate the [knob] to select [Yes/No] to reset the system → Press the knob to confirm the selection.



Status indication specification :

	Fan mode: Smart		Dimming curve: Linear
	Fan mode: High		Dimming curve: Exp
	Fan mode: Silent		Dimming curve: Log
	Bluetooth connected		Dimming curve: S
	DMX mode is enabled and the DMX console is connected. * This function can only be used by connecting to a GVM data box, which needs to be purchased separately. The supported data box models are: DCB-XLR5		The attachment is successfully connected and the corresponding function can be used. * This function can only be used by connecting to a GVM data box. The data box needs to be purchased separately. The supported data box models are: LCB-RJ45, CCB-XLR5

LIGHT

There are five lighting modes in total: CCT, HSI, RGB, color gel, and light source.

Rotate the [knob] to select the lighting mode → Press the [knob] to confirm the selection → rotate the [knob] to set the parameters → Press the [knob] to confirm the parameters → Press the [M] key to return to the previous level menu.

CCT

Adjusts the brightness and color temperature, the color temperature of the light can be adjusted from 2000K to 10000K.

INT: The brightness parameter of the light.

CCT: The color temperature parameter of the light.

G/M: The green/magenta offset parameter of the light.

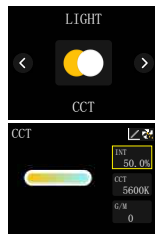

HSI

Adjusts the hue, saturation and brightness, the color of the light can be adjusted to achieve up-to 36 million colors.

INT: The brightness parameter of the light.

HUE: The color tone parameter of light.

SAT: Saturation parameter of the light.

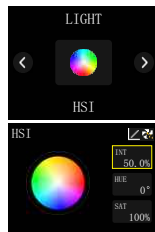

RGB

Adjust the red light, green light and blue light value to mix a specific color, in this mode you can achieve up-to 1.6X10¹⁰ million colors.

INT: The brightness parameter of the light.

R: The [R] red light parameter of the light.

G: The [G] green light parameter of the light.

B: The [B] blue light parameter of the light.

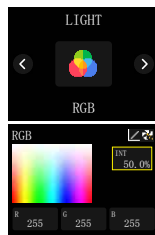

GEL

This mode can simulate 60 different type of industry standard color gel from CP-L and CP-R.

INT: The brightness parameter of the light.

3200K/5600K: Select the color temperature of the light.

CP-L/CP-R: Select between CP-L/CP-R gels.

Color gel: Select the included color gels

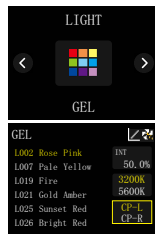

Source

This mode offers 12 types of light sources to choose from: tungsten filament lamps, 5600 dysprosium lamps, daylight dysprosium lamps, studio lamps, high-pressure sodium lamps, halogen lamps, short arc gas lamps, candlelight, sunrise/sunset, daytime, overcast, and fluorescent lamp.

Light source: Select the type of light source.

INT: The brightness parameter of the light.

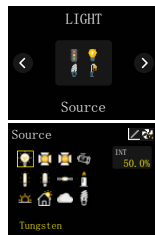

Effect mode

The effect mode can only be accessed through the APP / DMX / LumenRadio CRMX / Art-Net.

In this mode it offers 16 types of lighting effect presets: Lightning, CCT Loop, Candle, Bad Bulb, TV, Paparazzi, Explosion, Pulsing, Disco Cop Car Party, Hue Loop, Fireworks, Fire Engine, Ambulance, SOS.

DATA BOX FUNCTIONS AND INSTALLATION

Introduction to GVM Data Box Functions

Supports three types of GVM data boxes.

(GVM data boxes need to be purchased separately.)

DCB-XLR5

It features a 5-pin XLR in & out interface and supports the DMX512 / RDM protocol.

CCB-XLR5

It has a 5-pin XLR in & out interface and supports DMX512 / RDM and LumenRadio CRMX protocols.

LCB-RJ45

It has an RJ45 Ethernet in & out interface and supports the Art-Net protocol.

Steps for installing the GVM data box

1. Install the data box on the bottom side of the fixture with the included screws.
2. Plug in the DATA box to the DATA port on the fixture.

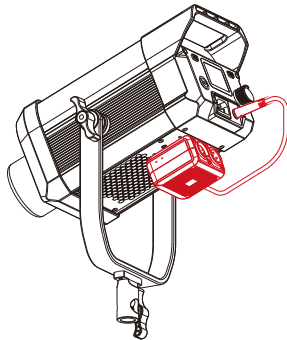
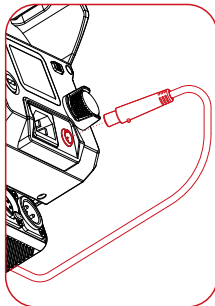
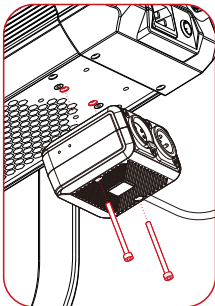

APP CONTROL

APP Download Method

(Scan the QR code on the back of the manual to download the APP)

Android Device: Official website QR code, Google Play, Huawei Store, etc.

iOS Device: App Store

Device-adding

1. Before adding a device, please make sure you have turned on your phone's Bluetooth and network data, accessibility to Bluetooth and network data, then reset the lighting device's Bluetooth.
2. Click the "Add Device" button on the "My Devices" page to find the Bluetooth light devices that have been turned on nearby. (Figure 1)
3. Select the device to be connected for pairing. (Figure 2)

* Android requires location permissions to be turned on in order to connect your device using mesh technology, and we do not collect any of your location information during this process.

Device Management

1. After successfully adding your lighting device, your device will be displayed in the "My Devices" list. (Figure 3)
2. Click on the Device to access the device control. (Figure 4)

Figure 1

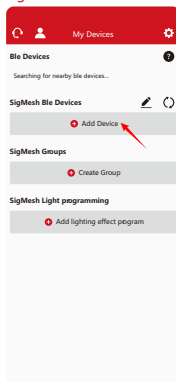

Figure 2

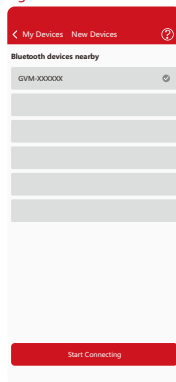

Figure 3

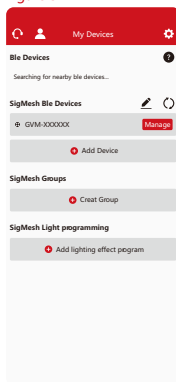
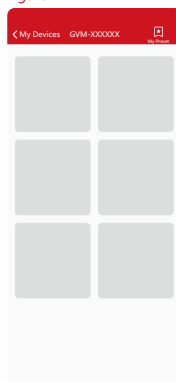

Figure 4



Account Login

- ◆ Use e-mail to get the verification code to log in (the first login automatically registers the account). (Figure 5)
- ◆ There may be a delay in sending the verification code, and the speed of delivery depends on the e-mail server you are using.
- ◆ Some email servers may recognize our verification emails as advertising promotions, please check your spam folder/inbox.
- ◆ After logging in, you can synchronize the Mesh Bluetooth devices bound to the current account to other smart devices.

Figure 5

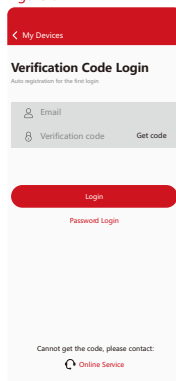

USE AND PRESERVATION

Do not place the product in a high humidity, strong electromagnetic field, direct sunlight, or high-temperature environment. If the product will not be used for a long time, please disconnect its power.

Cleaning: Unplug the power before cleaning. Use a dry cloth only—avoid cleaning agents or solventbased liquids, as they may damage the surface.

Power: Make sure the power is within the demanded range, not too high or too low.

Repairing: If there is a fault or performance degradation, do not unpack the shell by yourself, avoiding damage to the machine and losing the right of maintenance. When there is a fault, do not hesitate to contact us, and we will do our best to deal with the problem.

Accessories: Please use the accessories provided by the manufacturer and approved ones, to maximize the performance.

Warranty: Do not modify the product, or you will lose the right to maintenance.

QUICK TROUBLESHOOTING

Issue	Check the product	Troubleshooting
The indicator does not light up.	Whether the connection between the light and the power supply is normal.	Make sure the adapter is well connected with the power plug.
While using the APP to add a device, the Bluetooth of the device cannot be found.	Check if the device is turned on properly and that it is not already paired by someone else connection.	Follow these steps: 1. Turn on phone's Bluetooth and network data function, android devices need to turn on the GPS positioning. 2. Allow access to Bluetooth and network data, GPS positioning. 3. Reset the device Bluetooth according to the user manual.
The APP failed to pair to a device.	Check if the device is turned on properly and has not been connected or paired by others; Check if the Bluetooth and network conditions of the cell phone are good.	Reset the device Bluetooth and restart the app then try to connect again.
The device is no longer searchable after removing it from the APP.	Check if the device have been removed while it is off-lined or in poor network conditions.	Reset the device Bluetooth and then search again to add the device.
In-app device controls can not be accessed.	Check if the device is online; If it's off-line, please advice to the Distribution Network Connection Failure steps.	Reboot the device, wait for 5 seconds, wait till it shows as online status. To control it; Reset the device Bluetooth and then add the device back to the device list.

PACKING LIST

Name	Quantity	Notes
SD300C AIO	1	
AC power cord	1	

PRECAUTIONS

1. Please only use the included original power adapter to power the product. Do not use non-original power adapter to power the product.
2. The product is not waterproof, please use it in a rainproof environment.
3. The product is not anti-corrosion, therefore do not let the product touch any corrosive liquid.
4. When using the product, make sure the product is put firmly and prevents falling and damage.
5. If the product will not be used for a long time, please switch off the power to reduce energy loss.

PRODUCT WARRANTY

Dear user, this warranty card is important proof for applying for warranty service. Please cooperate with the salesperson to fill it out and keep it properly. Thank you!

Product Information	Model Number	Product Barcode
User Information	Name	Contact Number
	Mailing Address	
Seller Information	Name	
	Contact Number	
	Mailing Address	
	Sales Date	
Remarks		

Note: this form should be confirmed by the salesperson's stamp.

Applicable Products

This document applies to the products listed in the relevant "Product Warranty Information" (see instructions below). Other products or components that do not fall within this scope (such as promotional products, gift items, and other components added after the factory) are not covered by this warranty promise.

Warranty Period

The corresponding warranty period for products and components shall be executed according to the relevant "Product Warranty Information". The warranty period starts from the first day of purchase of the product, and the date of registration on the warranty card at the time of purchase shall prevail.

How to Obtain Warranty Service

You can directly contact the product salesperson or authorized service agency, or call GVM's after-sales service hotline to contact us and have our service personnel arrange service for you. When applying for warranty service, you should provide a valid warranty card as a warranty certificate to be eligible for warranty service. If you cannot provide a valid warranty card, we may also provide you with warranty service under the circumstance that our products or components are confirmed to be within the warranty scope, but this is not our obligation.

Cases where warranty does not apply:

If the product meets the following conditions, the warranty and service under this document will not apply:

1. The product or parts have exceeded the corresponding warranty period.
2. Malfunctions or damages caused by incorrect or improper use, maintenance, or storage, such as improper handling, use for purposes other than the reasonable expectations of the product, incorrect insertion or removal of external devices, falling or crushing due to external force, or exposure to inappropriate temperature, solvents, acids, alkalis, water immersion, or damp environments.
3. Malfunctions or damages caused by unauthorized installation, repair, modification, addition, or disassembly by institutions or personnel not authorized by GVM.
4. Modifications, changes, or removals of the original identification information of the product or its parts.
5. Lack of valid warranty card.
6. Malfunctions or damages caused by the use of unauthorized, non-standard or non-publicly released software.
7. Malfunctions or damages caused by force majeure or accidents.
8. Other malfunctions or damages not caused by quality issues of the product itself. In such cases, you should seek solutions from the relevant responsible parties, and GVM will not be held liable. Malfunctions or damages caused by components, accessories, or software not covered by the warranty or beyond the warranty scope that renders the product unable to function properly are not covered by the warranty. Fading, wear, and consumption that is normal during the product usage process are not covered by the warranty.

Product Warranty and Service Support Information

The product warranty period and service types are implemented according to the following "Product Warranty Information" for each product category, component, and optional equipment:

Product Category	Accessories Name	Warranty Period(Month)	Warranty Service Type
Component	Circuit Board.	12 Month	Customer service repair
Other	Spotlight mount, softbox, adapter, Standard reflector, power cord, battery Handle, light stand, TYPE-C cable, battery slot, battery, Fresnel lens, grid, carrying bag and all other accessories, etc. Consumable or electrically sensitive parts are not covered by the warranty.	None	No Warranty

QC
PASS



GVM Official website



Facebook



Download APP

Huizhou Latu Film Equipment Co., Ltd.

Web: www.gvmled.com

B&H Email: bh@gvmled.com

GVM Email: support@gvmled.com

Amazon Email: amazonsupport@gvmled.com

Warehouse Address: 12285 MCNULTY RD, STE 105 PHILADELPHIA, Pennsylvania 19154, USA