

GVM

GVM F500B AIO

CONTENTS

IMPORTANT SAFETY INSTRUCTIONS

This product is professional lighting and staging equipment and should only be operated by a qualified lighting technician or used under the supervision of a professional. Always follow the precautions below to ensure safe and proper usage.





1. Read the product manual carefully before use.
2. This product is only suitable to use in a temperature range of -10°C to 40°C.
3. Do not place the equipment near flammable and volatile solvents such as alcohol and gasoline.
4. Before storing the device, make sure it has cooled down completely. When being stored, unplug the power cord from the device. The equipment should be stored in its carrying case or a well-ventilated and dry place.
5. This lighting fixture is not for general illumination and should not be used as such. Individuals with eye injuries or sensitivity should avoid using this lighting fixture.
6. This is a professional light and children are prohibited from using it. Parents or guardians must closely supervise children when they are near the equipment to prevent personal injury caused by colliding with or misusing the equipment.
7. Before using the equipment, please remove the protective cover.
8. When the lighting fixture is on, it is forbidden to stare directly at the light source under any circumstances. High-intensity lighting should only be used under the guidance of a professional lighting technician. Avoid staying in a high-intensity light environment for a long time. If feeling any discomfort, please immediately turn off the lighting fixture, and seek medical attention.
9. When the lighting fixture is on, use it carefully and avoid contacting high-temperature components such as LED light sources to prevent being burnt.
10. Do not use damaged equipment or accessories. Wait for a professional repairman to inspect and repair it before it is confirmed that the equipment can function normally.
11. If the light source is damaged or deformed due to heat, please stop using it and contact the manufacturer, service agents, or qualified repairman promptly to replace the light source to avoid accidents.
12. If the product is cracked due to falling, squeezing, or strong impact during use, please stop use it to avoid being electrically shocked by touching internal electronic components.
13. Do not disassemble the product by yourself. If the product malfunctions, it must be checked and repaired by the manufacturer or authorized repair personnel.
14. Before cleaning and maintenance, be sure to unplug the power supply. To unplug never pull on the cable but always pull the plug itself. This device shall only operate with earthed power outlets or emergency power generators.
15. When cleaning the device, do not wipe it with a wet cloth. Use a dry and soft cloth to wipe off the dirt.
16. If an extension cord is required, it needs to have the necessary capacity to power the respective unit. Using an extension cord with a lower current capacity than the devices need may cause overheating.

17. For some products with long power cords, please place the power cords properly and avoid contact with overheated surfaces that may damage or trip personnel. Please use the original power cords of our manufactory. The damage caused by using non-original power cords is not covered by our repair service.
18. Do not use product accessories that are not recommended by our brand to avoid fire, electric shock, or personal injury.
19. Some products use batteries for power supply. Do not use any batteries, power sources, or accessories that are not specified in the user manual. Please keep batteries and other accessories out of reach of children and infants. If a child or infant swallows a battery or accessory, seek medical attention immediately. If the battery leaks, changes color, deforms, smokes, or emits an odor, remove it immediately. Be careful not to get burned during the removal. Continued use of such batteries may cause a fire, electric shock, or skin burns. Do not use any deformed or modified batteries. Do not disassemble or modify this product or the battery. Do not heat the battery or solder it. Do not let the battery come into contact with fire or water, or subject it to strong external force. Do not insert the battery's positive and negative ends incorrectly, or mix and use old and new batteries or different types of batteries.
20. For some products with built-in lithium batteries, please use a dedicated charger for charging, and following the correct operating instructions within the prescribed voltage and temperature range.
21. The warranty last for one year. Consumables like batteries, adapters, power cords, and other accessories are not covered by the warranty.
22. The one-year warranty will be invalidated if the equipment is found to have been repaired privately. The related repair costs will be charged.
23. Equipment malfunctions caused by non-standard operations are not covered by the warranty.
24. The safety instructions are based on our factory's strict testing. If there are any changes in the equipment's design and specifications, we reserve the right not to notify you. Customers can visit our official website to check the latest digital version of the instructions and learn about the newest product information.

Keep these instructions!



WARNING:

-  High-power LED lights are strictly prohibited from being directly viewed or shining into other people's eyes.
-  Do not unplug the power cord or connecting wires while the light is on to avoid personal injury.
-  Do not cover the heat dissipation port when the lamp is in operation.
-  Keep children away from touching or using this light.
-  As professional lighting equipment, please make sure to operate it correctly according to the user manual.

PRODUCT INTRODUCTION

Thank you for purchasing the “GVM F500B AIO”. This product is specifically designed for lighting technicians and photography/ videography professionals. This product is suitable for use in live stream /outdoor /studio and YouTube productions.

The main features of the product are:

1. The light features step-less dimming and is equipped with a single Bi-color COB LED light engine that is rated at CRI & TLCI 97+. Its capable of producing bi-color temperature range of 2700K to 6800K and can greatly enhance contrast in scenes, with realistic and vibrant illumination.
2. Connect and control through your iOS and Android smart mobile devices; Supports Bluetooth Mesh networking and can be used for group control with other GVM brand devices that support Mesh networking.
3. **Optional GVM data modules are available for purchase separately.** The supported accessory models include: BCM-XLR5 (5-Pin DMX control), CCM-XLR5(CRMX+5-Pin DMX control), and LCM-RJ45(IP control).
4. 3 types of light modes: CCT mode, Source Matching mode (Only accessible through the APP), and Effects mode (Only accessible through the APP).
 - CCT Mode: Adjust the light's intensity and color temperature as needed.
 - Source Matching Mode: **The light source mode can only be used when controlled by the APP.** Choose from 12 simulated light sources: Tungsten, HMI5600, HMI6000, Studio Lamps, Sodium Lamp, Halogen, Arc Lamp, Candle, Sunset/Sunrise, Daylight, Overcast Sky, CFL Cool White.
 - Effects Mode: **Available when connected to the APP, or after installing the GVM data box. The lighting effects mode can be accessed with DMX/Lumen Radio CRMX/Art-Net control.** Choose from 12 simulated light effects: Lightning, CCT Loop, Candle, Bad Bulb, TV, Paparazzi, Explosion, Pulsing, Strobe, Fire, Fireworks, Welding.

We firmly believe that, proper use of this product will greatly enhance your production workflow. We strongly recommend reading the following user guide carefully before using the product.

DISCLAIMERS

1. Before using this product, please read the text carefully to ensure that the correct operation of the product has been carried out. Failure to follow and not following the instructions and warnings in this document may cause harm to you and others around you, or even damage the product or other surrounding items.
2. By using this product, you are deemed to have carefully read the disclaimer and warning, understand and acknowledge all the terms and contents of this statement, and promise to take full responsibility for the use of this product and the possible consequences.
3. Design and specifications are subject to change without notice.

PRODUCT PARAMETER

- ◆ Brand : GVM
- ◆ Product Model : GVM F500B AIO
- ◆ Product Name : LED Video Light
- ◆ Product Type : LED COB Light
- ◆ Features : Flat profile compact design, High CRI COB LED Chip
- ◆ Control Methods : On-board control,GVM Mesh Bluetooth APP Control,and Control though three types of data box accesossies(Purchased separately)
- ◆ The data port can be used to connect with the following accessories:
DCB-XLR5(DMX/RDM),
CCB-XLR5(CRMX/RDM),
LCB-RJ45(Ethernet Art-Net)
**The accessories needs to be purchased separately.*
- ◆ Bluetooth Controllable Distance : ≤50M
- ◆ Color Rendering Index : ≥97
- ◆ Color Temperature : 2700K~6800K
- ◆ Illuminance : 26000 lux@1m; 3000 lux@3m
- ◆ LED Chip Quantity : 1 (COB light Chip)
- ◆ Light Adjustment Method : Step-less adjustment
- ◆ Power : 500W
- ◆ Product Net Weight : 4.15kg
- ◆ Product Size (mm) : 246×252.5×128.5
- ◆ Power Supply Method : AC input
- ◆ Voltage : 100V~240V
- ◆ Cooling : Heat Sink Radiating + Cooling Fan
- ◆ Product Material : Aluminum alloy + Plastic
- ◆ Commodity Origin : Huizhou. China

PRODUCT STRUCTURE DIAGRAM

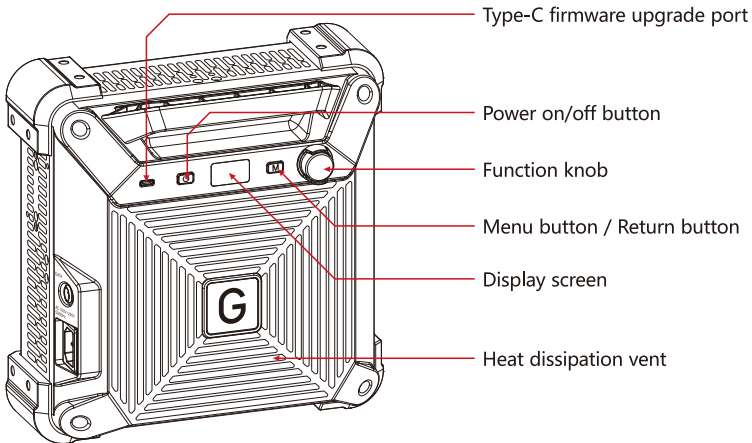
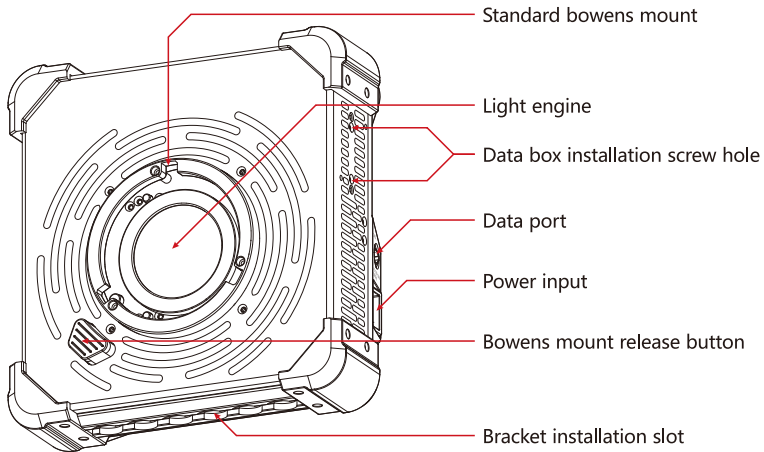

INSTALLATION METHOD

1 Product component overview.



Quick Release
Locking Pin



Light Head
Protective Cover

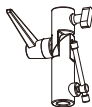

Swivel Light Stand
Mount

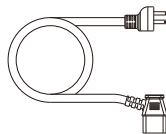

AC Power Cord

2 Install the Quick Release Locking Pin as shown in the following steps.

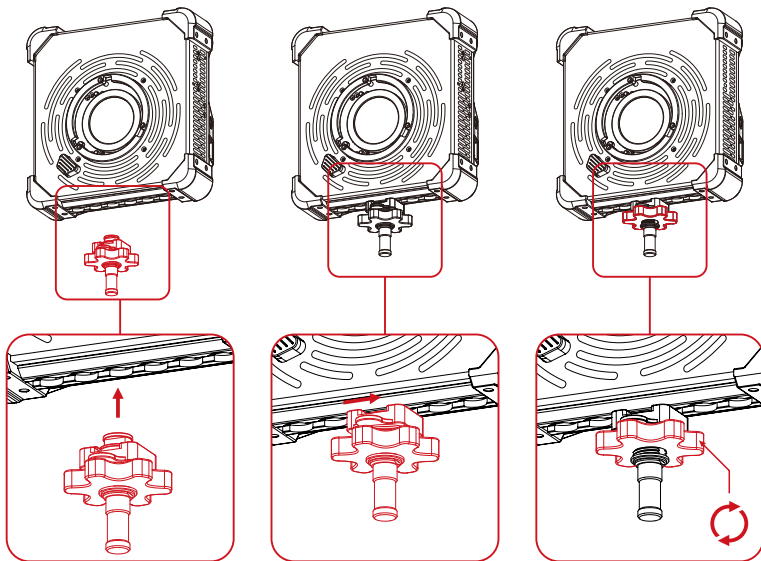

3 Detaching and attaching the protective cover

Detaching:

Press and hold the Bowens Mount Release Button then rotate the protective cover counterclockwise to remove it from the light.

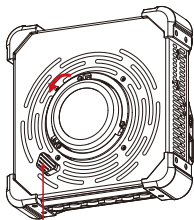

Bowens mount
release button

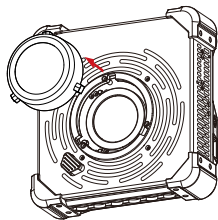

Attaching:

Align the three prongs on the protective cover cover with the corresponding sockets of the light → Insert and gently turn it clockwise to securely attach it to the light.

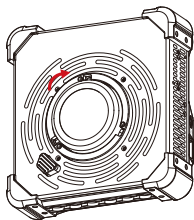
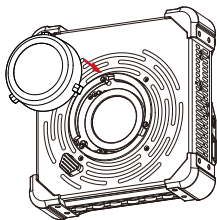

4 Installation of the Swivel Light Stand Mount

Loosen the knob on the swivel light stand mount, slide the end of the quick release locking pin into the swivel light stand mount, and then tighten the knob to secure it in place.

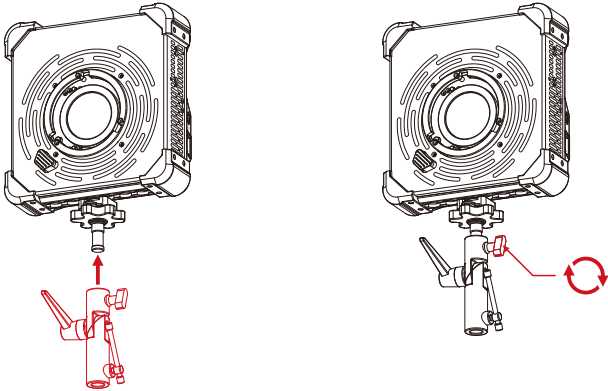

5 Angle adjustment

Loosen the handle on the swivel light stand mount to adjust the light to the desired position, then tighten to lock.

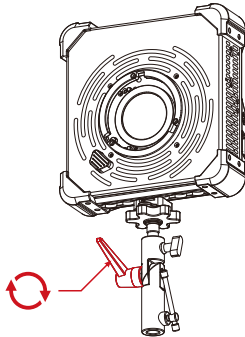

6 Attaching to the light stand

Position the swivel light stand mount directly above the light stand spigot. Gently slide the spigot into the receiving end of the mount. Tighten the locking knob on the side of the swivel mount to firmly secure the light to the stand.

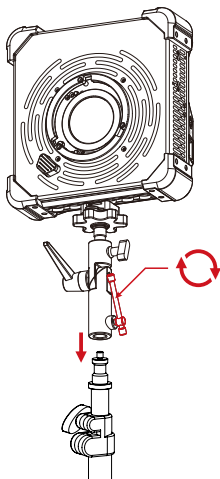

7 Connect the power cord for power supply.

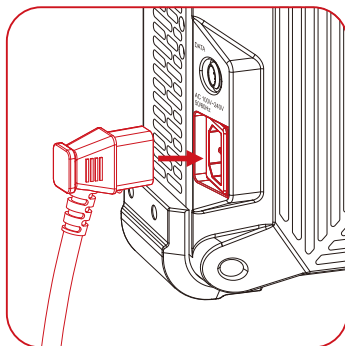
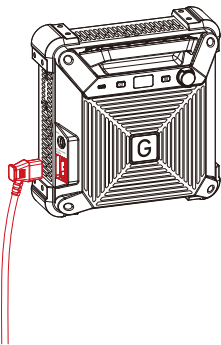

AC Input



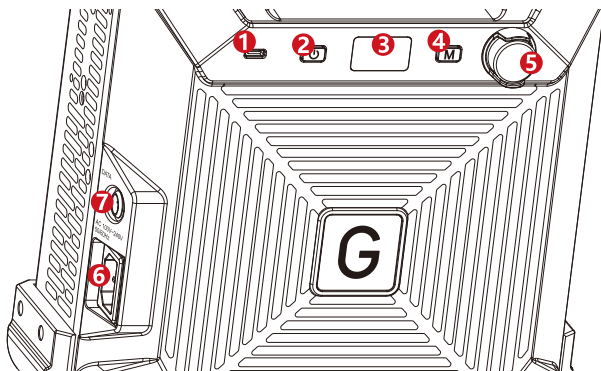







DESCRIPTION OF PRODUCT CONTROL KEYS



- 1** USB TYPE-C port: Support firmware update and data transmission.
(Does not support power pass through to the product or charging of mobile phones and other digital products externally.)
- 2** ON/OFF switch: Turn on or off the light.
- 3** Display: Displays the current settings, modes, and parameters.
- 4** Menu button / Return button:
【Long press】 Enter/exit the system menu interface.
【Short Press】 Return to the previous level menu.
- 5** Knob:
【Rotate】 Select a menu and adjust parameters.
【Click】 Go to the menu or confirm the selection.
- 6** Power port: Connect the power cable to supply power to the light.
- 7** Data interface: Connect the data box to implement DMX/LumenRadio CRMX / Art-Net control.
(The data box needs to be purchased separately.)

FUNCTION INTRODUCTION & INSTRUCTIONS FOR USE

① STATUS INDICATION

	Fan mode: Smart		Dimming curve: Linear
	Fan mode: High		Dimming curve: Exp
	Fan mode: Silent		Dimming curve: Log
	Bluetooth connected		Dimming curve: S
	DMX mode is enabled and the DMX console is connected (This function can only be used by connecting to the GVM data box. The data box needs to be purchased separately. The supported data box models are: DCB-XLR5.)		
	Ethernet control is enabled and connected to Ethernet. (This function can only be used by connecting to a GVM data box. The data box needs to be purchased separately. The supported data box models are: LCB-RJ45, CCB-XLR5.)		

③ MENU

Long press the [M] key to enter the system menu Settings → Rotate the [knob] to select the menu → Press the [knob] to enter the selected menu → Short press the [M] key to return to the previous level menu.

DMX SETTINGS

This function can only be enabled after connected to the GVM data box accessories.
(The data box accessories needs to be purchased separately. Supported data box models: DCB-XLR5, CCB-XLR5.)

Rotate the [knob] to select [DMX Address / DMX mode] → Press the [knob] to confirm the selection.

DMX Addr: Rotate the [knob] to set the DMX address number → Press the [knob] to confirm the setting.

DMX Mode: Rotate the [knob] to select DMX mode → Press the [knob] to confirm the selection.

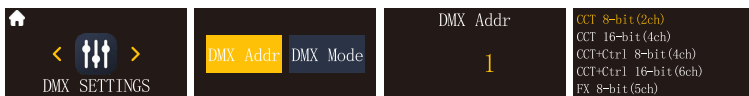

DIM CURVE

Rotate the [knob] to select the type of dimming curve [linear/logarithmic/exponential/S-type] → Press the [knob] to confirm the selection.

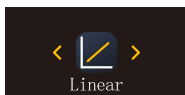

FAN SETTINGS

Rotate the [knob] to select [Smart/High/Silent] → Press the [knob] to confirm the selection.

Smart: Adjust the fan speed in response to temperature changes.

High: The fan operates at its maximum speed.

Silent: The silent mode will stop the fan from rotating and reduce the light output power to 30W. This mode is not recommended for long-term use.

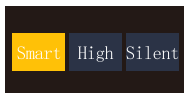

BLUETOOTH

Rotate the [knob] to select [BT State/BT Reset] → Press the [knob] to confirm the selection.

BT status: Rotate the knob to select [On/Off] Bluetooth → Press the knob to confirm the selection.

BT Reset: Rotate the knob to select [Yes/No] to reset Bluetooth → Press the knob to confirm the selection.

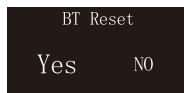
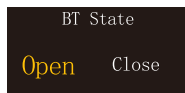

CRMX

This function can only be used after being connected to the GVM data box.

(The data box needs to be purchased separately. Supported data box model: CCB-XLR5.)



- After being connected to the CCB-XLR5 data box, it supports the DMX512 / RDM LumenRadio CRMX protocol.



Ethernet

This function can only be used after being connected to the GVM data box.

(The data box needs to be purchased separately. Supported data box models: LCB-RJ45.)



- After being connected to the LCB-RJ45 data box, it supports the Art-Net protocol.

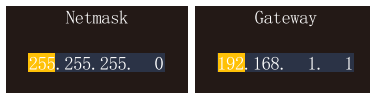

STUDIO

Rotate the [knob] to select [ON/OFF] → Press the [knob] to confirm the selection.
ON: Studio mode. In a power-off state, the equipment will automatically start up after being powered on.

OFF: Non-studio mode. In a power-off state, the equipment needs to be manually turned on after being powered on.

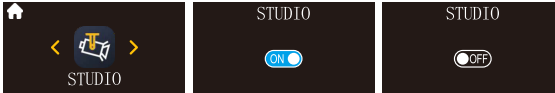

UPGRADE

Download the upgrade file from the official website to the root directory of the USB drive → Connect the USB drive with the upgrade firmware to the light → Navigate to the upgrade sub menu page rotate the [knob] to select [Yes/No] upgrade → Press the [knob] to confirm the selection. This procedure can be used to upgrade the operating firmware version of this product. (Supported USB flash drive format: FAT32)



SETTINGS

Rotate the [knob] to select [System Language/Product Information/Product Status/System Reset]→ Press the [Knob] to confirm the selection.

Language: Rotate the [knob] to select the language type [English/ Chinese]→ Press the [knob] to confirm the selection.

Products: View the firmware information of this product.

Status: View the current operating status of this product.

Reset: Rotate the [knob] to select [Yes/No] to reset the system → Press the knob to confirm the selection.

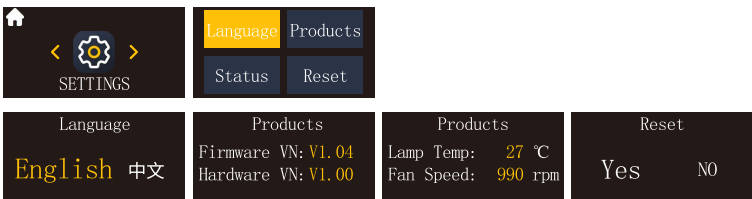

③ MODE

Rotate the [knob] to select [INT/CCT] → Press the [knob] to confirm the selection → rotate the [knob] to set the parameters → Press the [knob] to confirm the parameters.

INT: Intensity parameter of light.

CCT: Color temperature parameter of light.



④ Source Matching Mode

The light source mode can only be accessed through the APP.

Choose from 12 simulated light sources: Tungsten, HMI5600, HMI6000, Studio Lamps, Sodium Lamp, Halogen, Arc Lamp, Candle, Sunset/Sunrise, Daylight, Overcast Sky, CFL Cool White.

⑥ Effects Mode

The effect mode can be accessed through the APP, Or by installing the GVM data box accessories, the light effect mode can be used in DMX/Lumen Radio CRMX/Art-Net control.

Choose from 12 simulated light effects: Lightning, CCT Loop, Candle, Bad Bulb, TV, Paparazzi, Explosion, Pulsing, Strobe, Fire, Fireworks, Welding.

DATA BOX INSTALLATION & FUNCTIONS

Introduction to GVM Data Box Functions

Supports three types of GVM data boxes.

(GVM data boxes need to be purchased separately.)

DCB-XLR5

It features a 5-pin XLR in & out interface and supports the DMX512 / RDM protocol.

CCB-XLR5

It has a 5-pin XLR in & out interface and supports DMX512 / RDM and LumenRadio CRMX protocols.

LCB-RJ45

It has an RJ45 Ethernet in & out interface and supports the Art-Net protocol.

Steps for installing the GVM data box

1. Install the data box on to the side of the light with the included screws.
2. Connect the cable from the DATA box to the DATA port on the light.

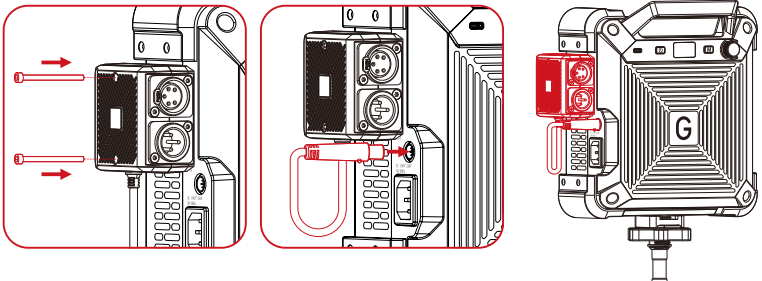

APP CONTROL

APP Download Method

(Scan the QR code on the back of the manual to download the APP)

Android Device: Official website QR code, Google Play, Huawei Store, etc.

iOS Device: App Store

Device-adding

1. Before adding a device, please make sure you have turned on your phone's Bluetooth and network data, accessibility to Bluetooth and network data, then reset the lighting device's Bluetooth.
2. Click the "Add Device" button on the "My Devices" page to find the Bluetooth light devices that have been turned on nearby. (Figure 1)
3. Select the device to be connected for pairing. (Figure 2)

* Android requires location permissions to be turned on in order to connect your device using mesh technology, and we do not collect any of your location information during this process.

Device Management

1. After successfully adding your lighting device, your device will be displayed in the "My Devices" list. (Figure 3)
2. Click on the Device to access the device control. (Figure 4)

Figure 1

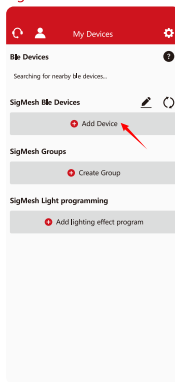

Figure 2

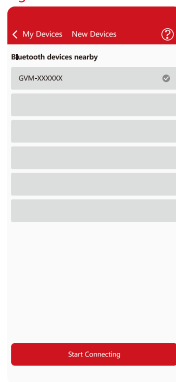

Figure 3

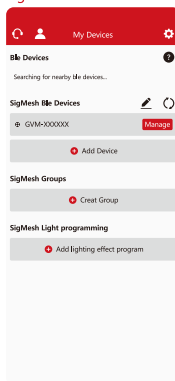
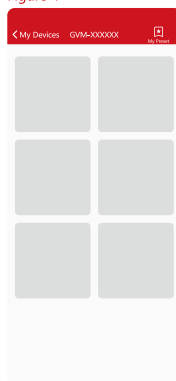

Figure 4



Account Login

- ◆ Use e-mail to get the verification code to log in (the first login automatically registers the account). (Figure 5)
- ◆ There may be a delay in sending the verification code, and the speed of delivery depends on the e-mail server you are using.
- ◆ Some email servers may recognize our verification emails as advertising promotions, please check your spam folder/inbox.
- ◆ After logging in, you can synchronize the Mesh Bluetooth devices bound to the current account to other smart devices.

Figure 5

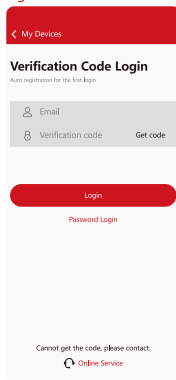

QUICK TROUBLESHOOTING

Issue	Check the product	Troubleshooting
The indicator does not light up.	Whether the connection between the light and the power supply is normal.	Make sure the adapter is well connected with the power plug.
While using the APP to add a device, the Bluetooth of the device cannot be found.	Check if the device is turned on properly and that it is not already paired by someone else connection.	Follow these steps: 1. Turn on phone's Bluetooth and network data function, android devices need to turn on the GPS positioning. 2. Allow access to Bluetooth and network data, GPS positioning. 3. Reset the device Bluetooth according to the user manual.
The APP failed to pair to a device.	Check if the device is turned on properly and has not been connected or paired by others; Check if the Bluetooth and network conditions of the cell phone are good.	Reset the device Bluetooth and restart the app then try to connect again.
The device is no longer searchable after removing it from the APP.	Check if the device have been removed while it is off-lined or in poor network conditions.	Reset the device Bluetooth and then search again to add the device.
In-app device controls can not be accessed.	Check if the device is online; If it's off-line, please advice to the Distribution Network Connection Failure steps.	Reboot the device, wait for 5 seconds, wait till it shows as online status. To control it; Reset the device Bluetooth and then add the device back to the device list.

USE AND PRESERVATION

Do not place the product in a high humidity, strong electromagnetic field, direct sunlight, or high-temperature environment. If the product will not be used for a long time, please disconnect its power.

Cleaning: Unplug the power before cleaning. Use a dry cloth only—avoid cleaning agents or solventbased liquids, as they may damage the surface.

Power: Make sure the power is within the demanded range, not too high or too low.

Repairing: If there is a fault or performance degradation, do not unpack the shell by yourself, avoiding damage to the machine and losing the right of maintenance. When there is a fault, do not hesitate to contact us, and we will do our best to deal with the problem.

Accessories: Please use the accessories provided by the manufacturer and approved ones, to maximize the performance.

Warranty: Do not modify the product, or you will lose the right to maintenance.

PRECAUTIONS

1. Please use the matching power adapter the same specification to power the product. Do not use power adapter with different output voltage parameters.
2. The product is not anti-corrosion, therefore do not let the product touch any corrosive liquid.
3. When using the product, make sure the product is put firmly and prevents falling and damage.
4. If the product will not be used for a long time, please switch off the power to reduce energy loss.

PACKING LIST

Name	Quantity	Notes
GVM F500B AIO	1	
Light Head Protective Cover	1	
Quick Release Locking Pin	1	
Swivel Light Stand Mount	1	
AC Power Cord	1	
Carrying Bag	1	

PRODUCT WARRANTY

Dear user, this warranty card is important proof for applying for warranty service. Please cooperate with the salesperson to fill it out and keep it properly. Thank you!

Product Information	Model Number	Product Barcode
User Information	Name	Contact Number
	Mailing Address	
Seller Information	Name	
	Contact Number	
	Mailing Address	
	Sales Date	
Remarks		

Note: this form should be confirmed by the salesperson's stamp.

Applicable Products

This document applies to the products listed in the relevant "Product Warranty Information" (see instructions below). Other products or components that do not fall within this scope (such as promotional products, gift items, and other components added after the factory) are not covered by this warranty promise.

Warranty Period

The corresponding warranty period for products and components shall be executed according to the relevant "Product Warranty Information". The warranty period starts from the first day of purchase of the product, and the date of registration on the warranty card at the time of purchase shall prevail.

How to Obtain Warranty Service

You can directly contact the product salesperson or authorized service agency, or call GVM's after-sales service hotline to contact us and have our service personnel arrange service for you. When applying for warranty service, you should provide a valid warranty card as a warranty certificate to be eligible for warranty service. If you cannot provide a valid warranty card, we may also provide you with warranty service under the circumstance that our products or components are confirmed to be within the warranty scope, but this is not our obligation.

Cases where warranty does not apply:

If the product meets the following conditions, the warranty and service under this document will not apply:

1. The product or parts have exceeded the corresponding warranty period.
2. Malfunctions or damages caused by incorrect or improper use, maintenance, or storage, such as improper handling, use for purposes other than the reasonable expectations of the product, incorrect insertion or removal of external devices, falling or crushing due to external force, or exposure to inappropriate temperature, solvents, acids, alkalis, water immersion, or damp environments.
3. Malfunctions or damages caused by unauthorized installation, repair, modification, addition, or disassembly by institutions or personnel not authorized by GVM.
4. Modifications, changes, or removals of the original identification information of the product or its parts.
5. Lack of valid warranty card.
6. Malfunctions or damages caused by the use of unauthorized, non-standard or non-publicly released software.
7. Malfunctions or damages caused by force majeure or accidents.
8. Other malfunctions or damages not caused by quality issues of the product itself. In such cases, you should seek solutions from the relevant responsible parties, and GVM will not be held liable. Malfunctions or damages caused by components, accessories, or software not covered by the warranty or beyond the warranty scope that renders the product unable to function properly are not covered by the warranty. Fading, wear, and consumption that is normal during the product usage process are not covered by the warranty.

Product Warranty and Service Support Information

The product warranty period and service types are implemented according to the following "Product Warranty Information" for each product category, component, and optional equipment:

Product Category	Accessories Name	Warranty Period(Month)	Warranty Service Type
Component	Circuit Board.	12 Month	Customer service repair
Other	Spotlight mount, softbox, adapter, Standard reflector, power cord, battery Handle, light stand, TYPE-C cable, battery slot, battery, Fresnel lens, grid, carrying bag and all other accessories, etc. Consumable or electrically sensitive parts are not covered by the warranty.	None	No Warranty

QC
PASS



GVM Official website



Facebook



Download APP

Huizhou Latu Film Equipment Co., Ltd.

Web: www.gvmled.com

B&H Email: bh@gvmled.com

GVM Email: support@gvmled.com

Amazon Email: amazonsupport@gvmled.com

Warehouse Address: 12285 MCNULTY RD, STE 105 PHILADELPHIA, Pennsylvania 19154, USA